

THE BEAUTIFUL

Chrysler

CHRYSLER'S

1940

Beauty



Beauty stems from many attributes—form, line, proportion, symmetry—often, color and motion play a part. Beauty may be restful, exciting, dynamic—and it can be functional, as well.

In the not too distant past, beauty in a motor car was a compromise; almost an afterthought, when the practical considerations of performance, safety, comfort and economy of production had been met.

Nowadays, however, the principles of functional design have been developed and applied so adroitly that no attribute of beauty need be sacrificed in creating a car that gladdens the eye of all who see it. Such a car, indeed, is today's beautiful Chrysler.

Your first impression, we know, will be one of delight and admiration—and if you try to analyze why, you will begin to see

that the compelling beauty of this car results from a perfect blending of many elements, each a thing of beauty in itself, yet all contributing to the charm and grace of the entire car.

The loveliness of perfect symmetry is apparent from every point of vision, whether one views the car from the front, the side, the rear or from a quartering angle. Functionally, the lines that delight your eye are "streamlines" that substantially reduce wind resistance, yet they are so disposed in form and proportion that all the elements of beauty and distinction are preserved and emphasized.

The beautiful Chrysler for 1940 is created for those who believe that beauty in a motor car can be attained without resorting to extremes of modernism, that so often result in something garish and grotesque.

Pride of **OWNERSHIP**

No one can take pride in a possession that lacks any essential of complete satisfaction. That is a truism that applies most precisely to the ownership of a motor car, where so many varied factors are present to tip the scales of satisfaction one way or the other.

Many owners tend to regard some one specific factor as a paramount consideration. One person may regard beauty as the essential attribute—another may emphasize speed or acceleration—with a third, comfort is all-important—but the average driver likes to feel that all the wanted attributes of fast, safe, comfortable travel are embodied in the car he owns.

You will be proud to own the beautiful new Chrysler for 1940, because every line of these superb models conveys unmistakable distinction, character and leadership. And

beneath their smart, sleek exteriors are mechanical elements completely in tune with the demands of modern motoring

No one need be persuaded that these cars are beautiful—the first glance confirms it. No one can doubt that they are fast and able under every condition—for this is the natural heritage of all Chryslers. No one can hope to find safer cars—for Chrysler's emphasis on safety is an established tradition. No one can lack faith in their stamina and long life—the supporting record of all Chryslers since 1924 is too abundant and conclusive.

Go see these new, beautiful Chryslers for 1940—take a demonstration—drive one yourself. When you do, you will be convinced that The Beautiful Chrysler is the car you can own with pride and drive with confidence.



THE EIGHT PASSENGER SEDAN LIMOUSINE

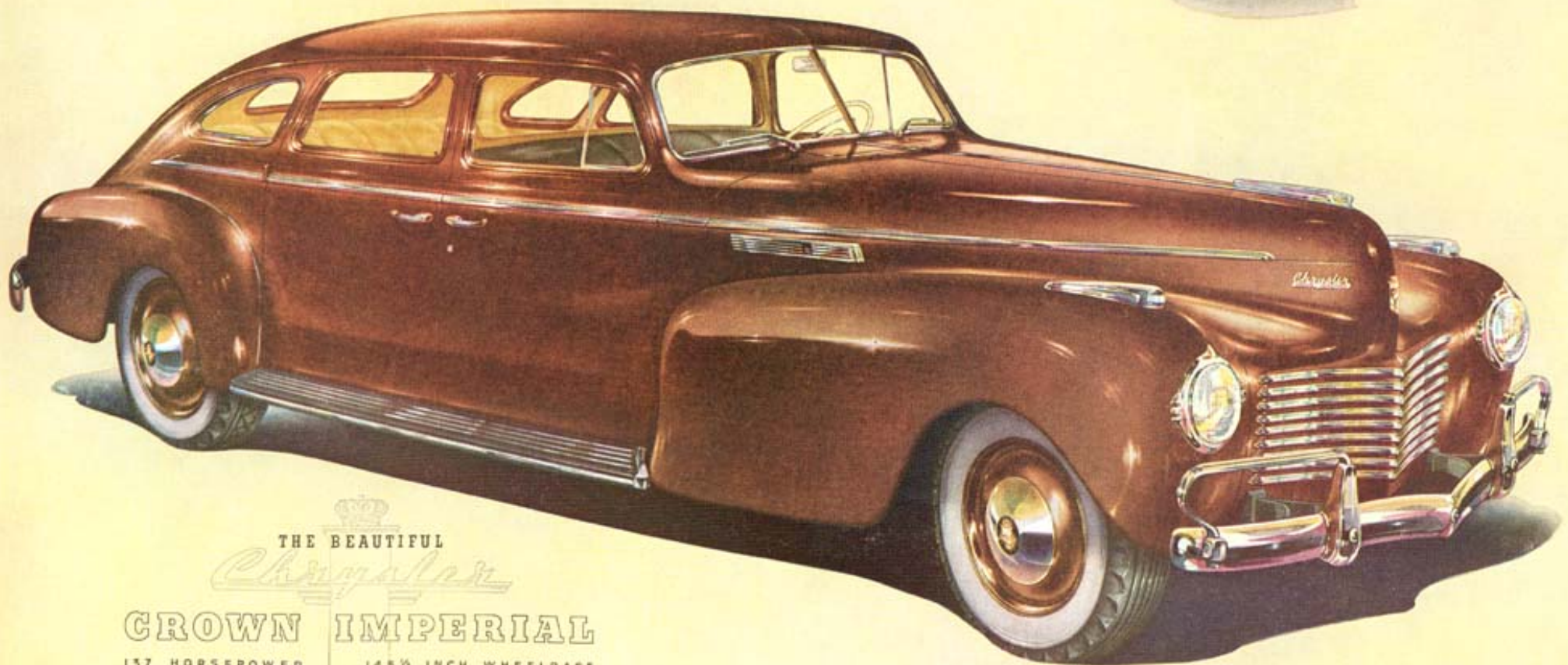

THE BEAUTIFUL
Crown Imperial
CROWN IMPERIAL
137 HORSEPOWER 145 1/2 INCH WHEELBASE

THE SIX PASSENGER SEDAN

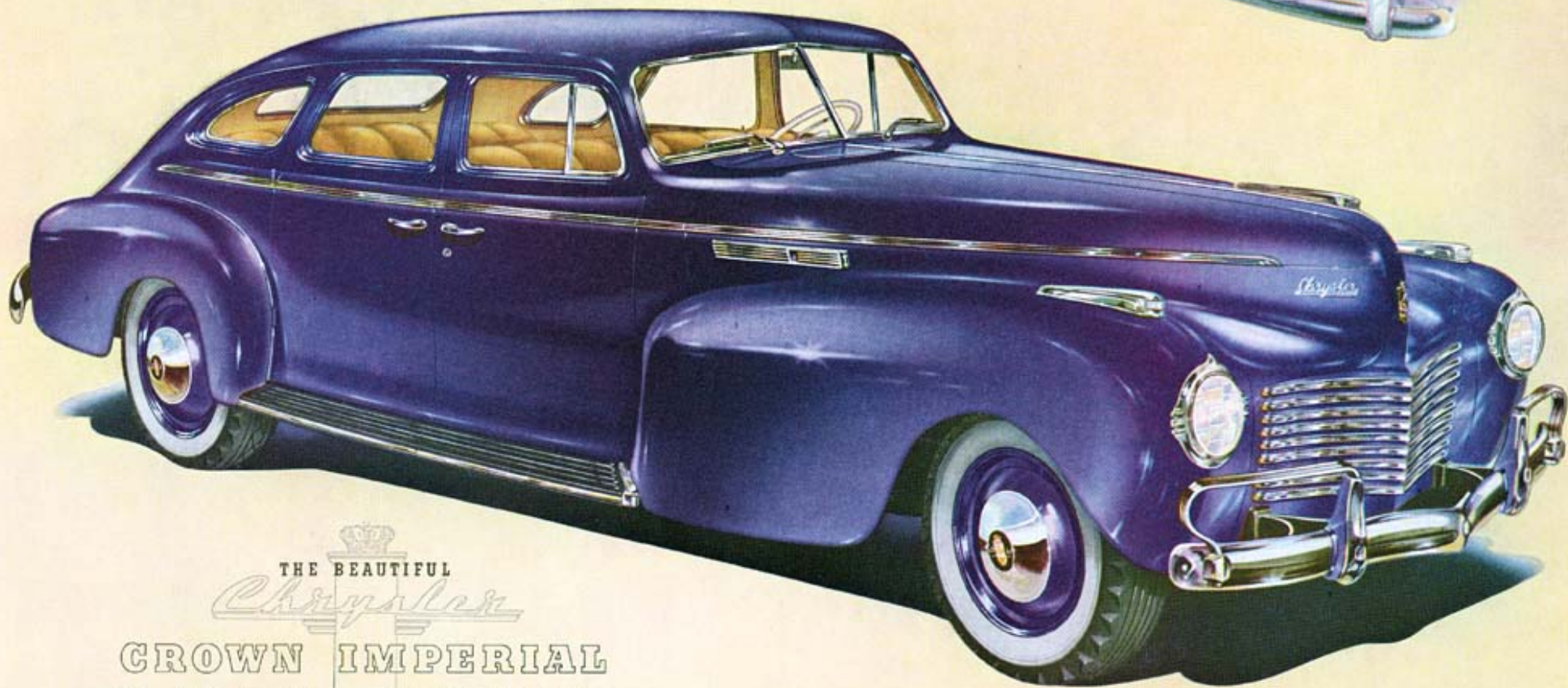

THE BEAUTIFUL
Crown Imperial
CROWN IMPERIAL
137 HORSEPOWER 145 1/2 INCH WHEELBASE

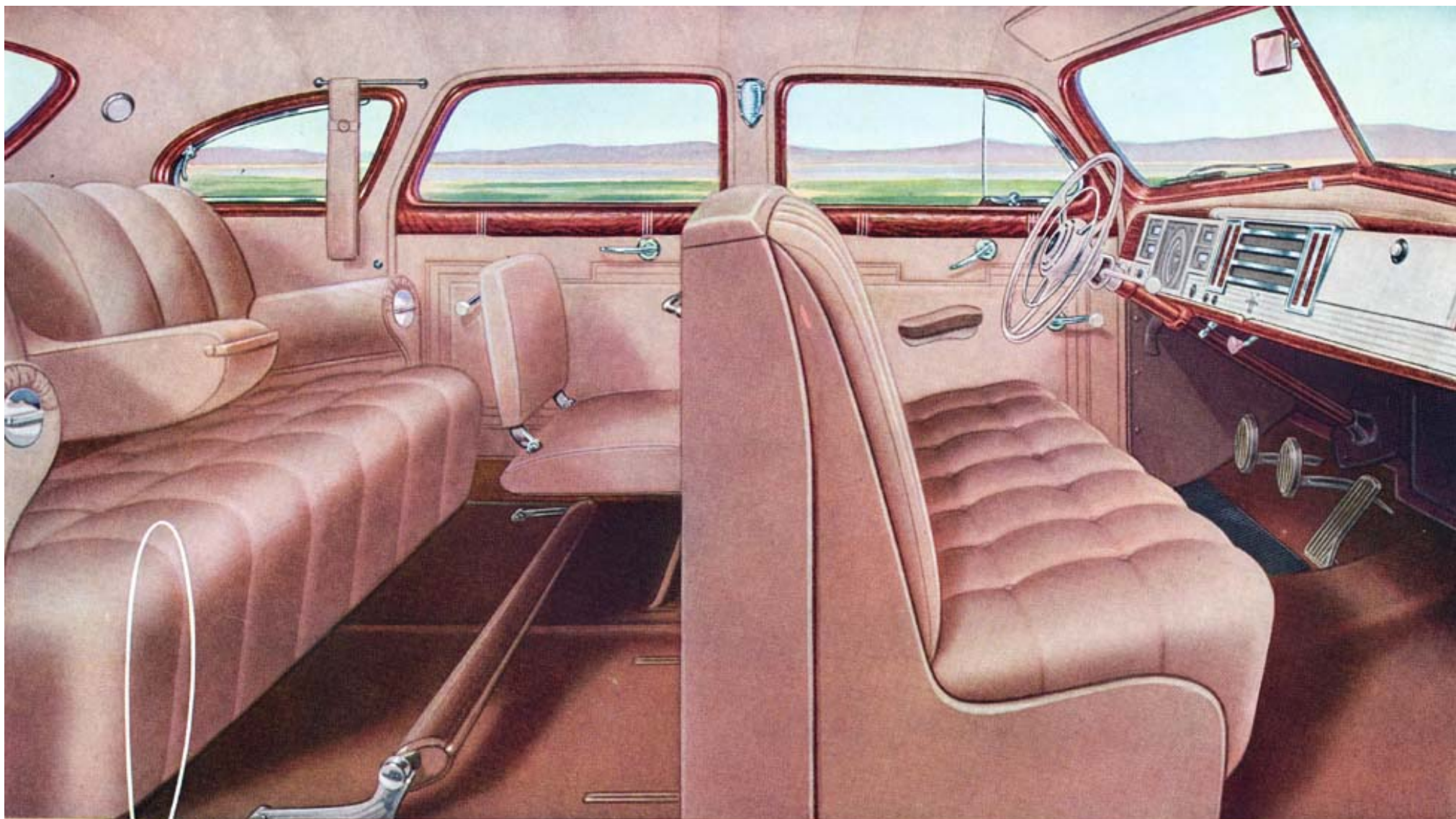

Interior

THE BEAUTIFUL CHRYSLER CROWN IMPERIAL EIGHT PASSENGER SEDAN



Custom built, to satisfy the very discriminating requirements of those to whom cost is not important, Chrysler presents for the Crown Imperial 8-passenger Sedan an interior impeccable in its appointments and designed for the utmost in comfort and luxury.

This interior is identical with that of the Crown Sedan-Limousine, except that in the latter, front seat upholstery is black leather, and a sliding glass partition may be closed to insure complete privacy for rear seat passengers when the car is chauffeur driven.

THE EIGHT PASSENGER SEDAN

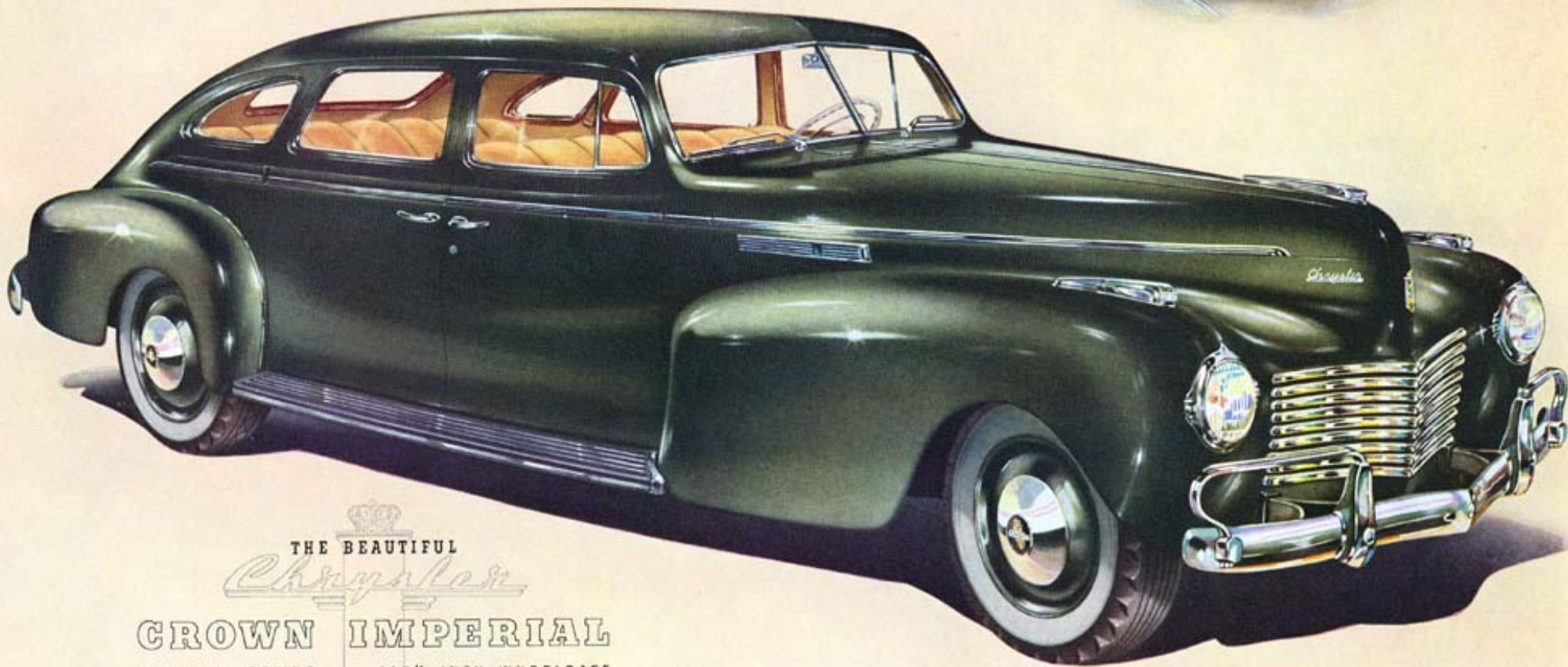

THE BEAUTIFUL
Chrysler
CROWN IMPERIAL
137 HORSEPOWER 145 1/2 INCH WHEELBASE

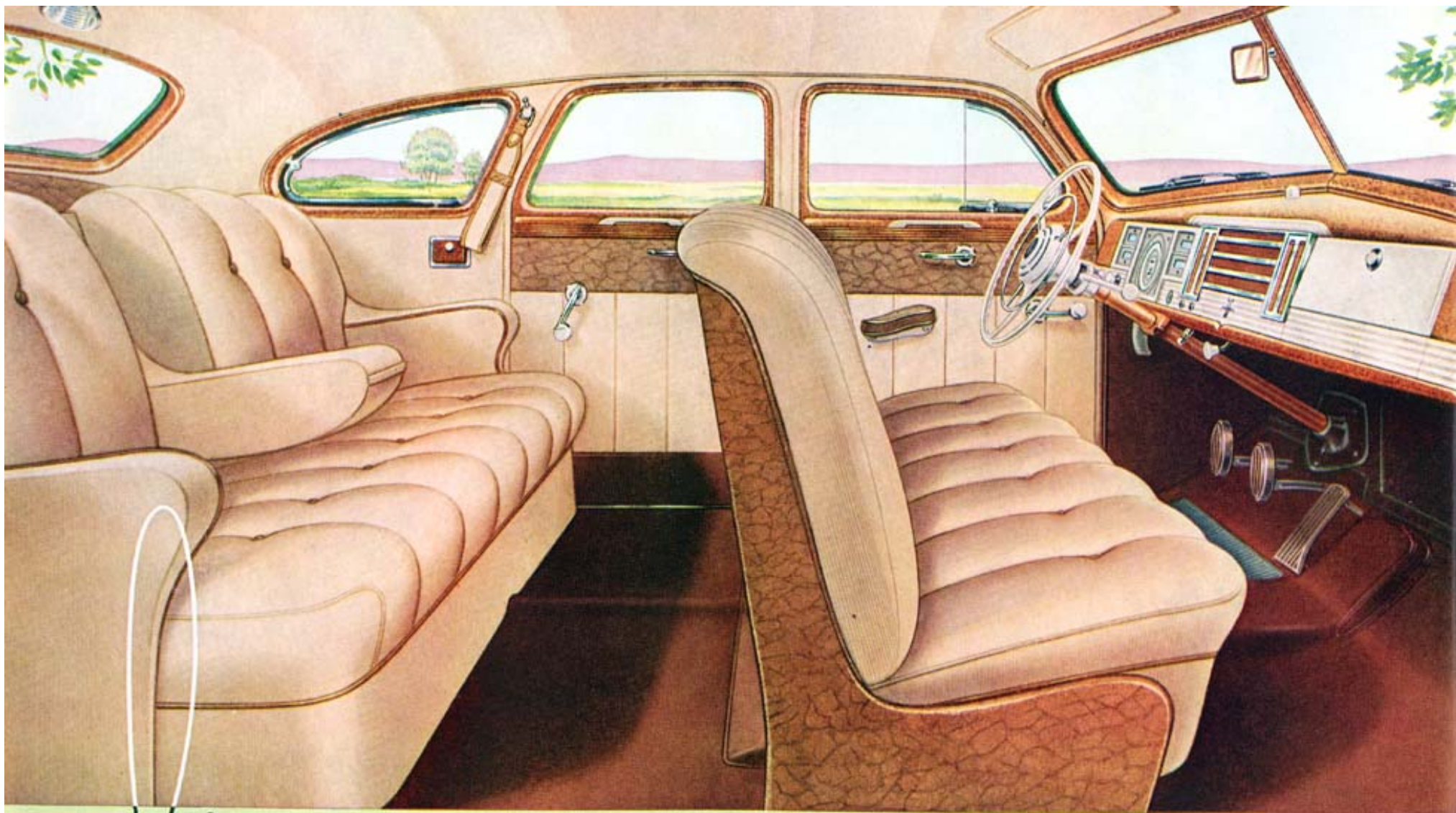

Interior

THE BEAUTIFUL CHRYSLER SARATOGA SIX PASSENGER SEDAN



The interior of the Saratoga Sedan is upholstered in an unusual combination of Bedford Cord fabric and genuine top grain leather. Seat cushions, seat backs, arm rests and head lining are trimmed in tan colored fabric. An attractive shade of russet leather

covers the back of the front seat, lower quarters and shelf board. Leather also is used for binding on the assist straps, carpet and visors . . . and for buttons and welts. Here indeed is an interior delightfully different—yet unmistakably charming and attractive.

THE SIX PASSENGER SEDAN



THE BEAUTIFUL
Chrysler
SARATOGA
135 HORSEPOWER 128 1/2 INCH WHEELBASE

THE CHRYSLER

New Yorker



Distinction and individuality find expression in the New Yorker and in the Windsor through a choice of smart and striking upholstery options. Four two-tone combinations are available using blue, green, brown, maroon, as illustrated above. Seat

cushions and backs are upholstered in the darker tone, and the headlining, rear quarter panels and center of door panels are trimmed in the lighter, contrasting shade. Special quality carpeting, to harmonize with each color scheme is provided.

THE SIX PASSENGER SEDAN

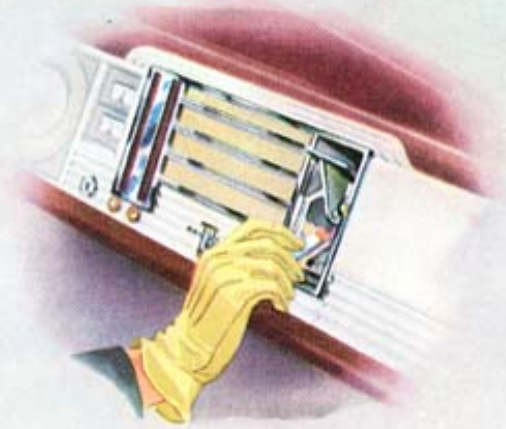

THE BEAUTIFUL
Chrysler
NEW YORKER
135 HORSEPOWER 128 1/2 INCH WHEELBASE

THE VICTORIA SEDAN



THE BEAUTIFUL
Chrysler
NEW YORKER
135 HORSEPOWER 128 1/2 INCH WHEELBASE

THE CONVERTIBLE COUPE

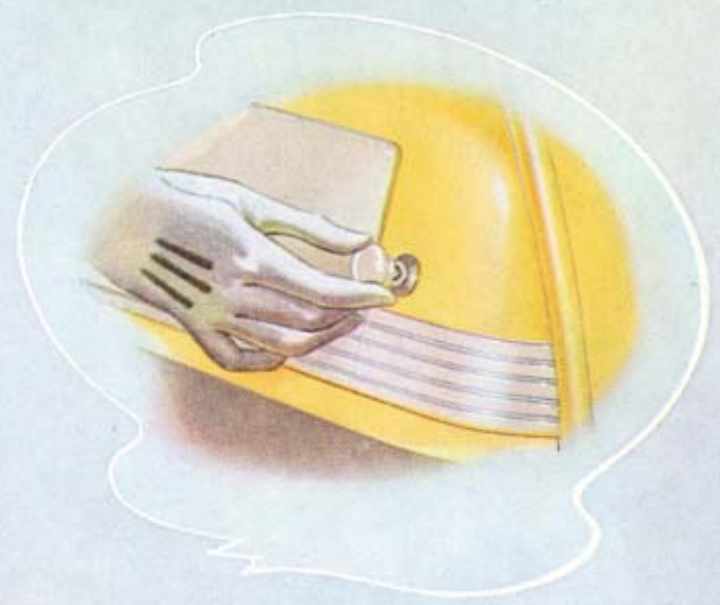

THE BEAUTIFUL
Chrysler
NEW YORKER
135 HORSEPOWER 128 1/2 INCH WHEELBASE

THE THREE PASSENGER COUPE *and* SIX PASSENGER COUPE

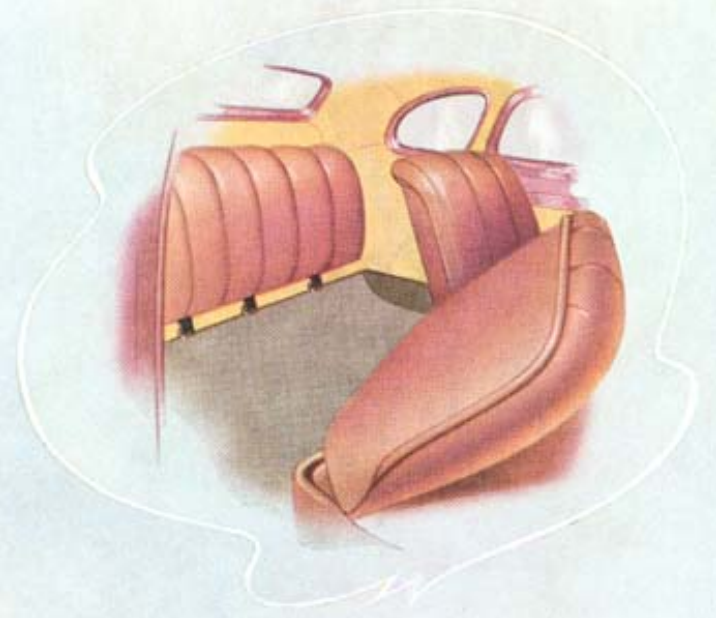

THE BEAUTIFUL
Chrysler
NEW YORKER
135 HORSEPOWER 128 1/2 INCH WHEELBASE



Interior

THE BEAUTIFUL CHRYSLER NEW YORKER SIX PASSENGER SEDAN



In addition to the two-tone blue shown above, there are three other optional interior stylings available for the New Yorker—contrasting shades of green, maroon and brown. Individual

preference thus finds expression in this smart distinctive and beautiful Chrysler, with its many extra items of quality equipment that add so definitely to comfort, convenience and luxury.

THE SIX PASSENGER SEDAN

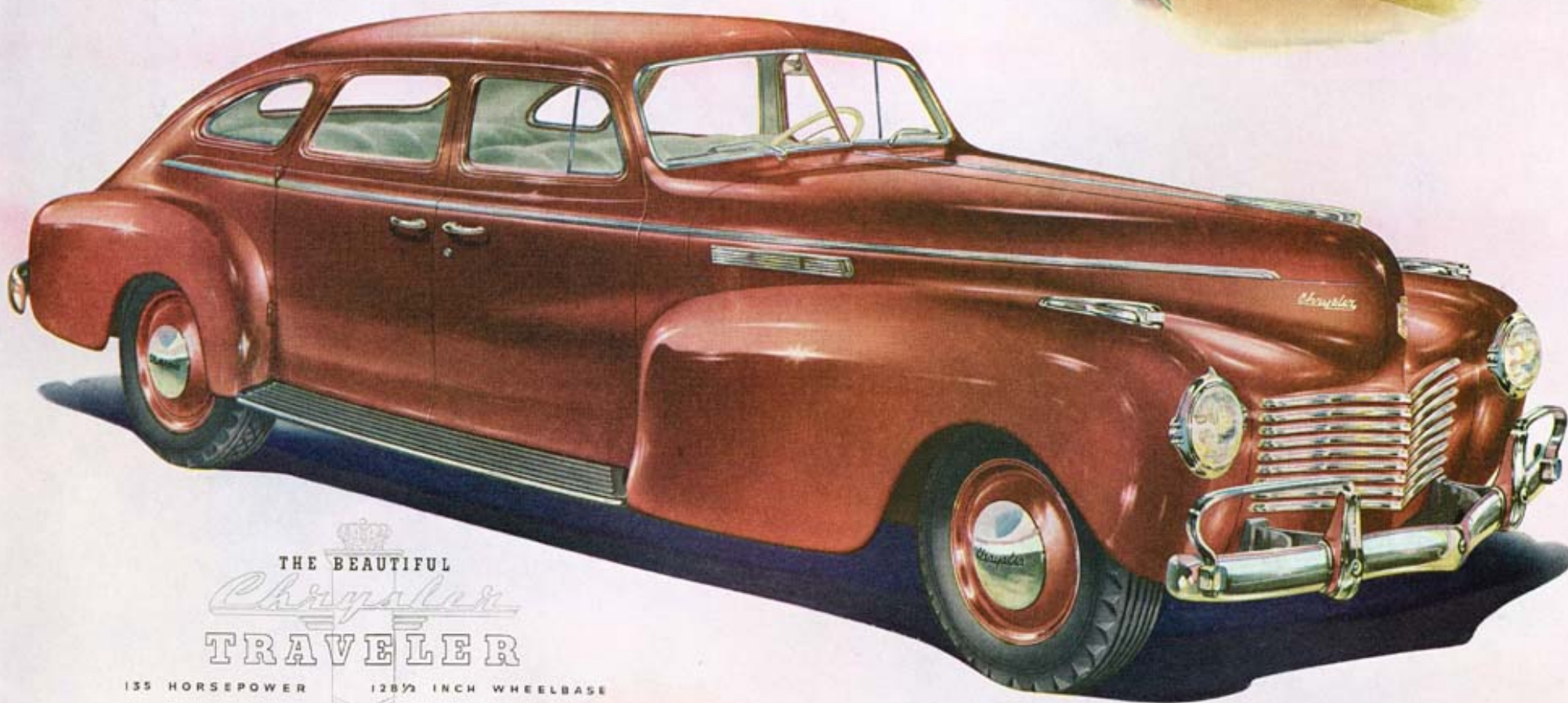

THE BEAUTIFUL
Chrysler
TRAVELER

135 HORSEPOWER

128 1/2 INCH WHEELBASE

THE VICTORIA SEDAN

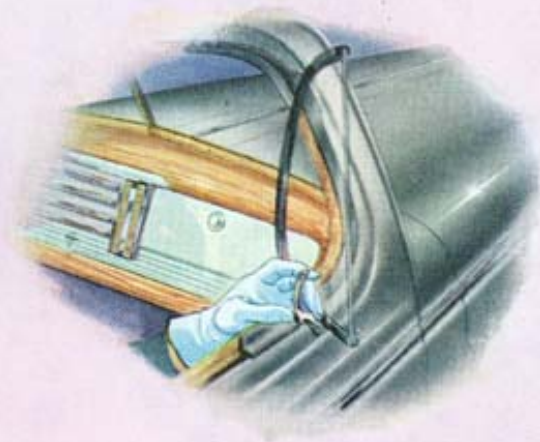

THE BEAUTIFUL
Chrysler
TRAVELER

135 HORSEPOWER

128 1/2 INCH WHEELBASE

THE THREE PASSENGER COUPE *and* SIX PASSENGER COUPE

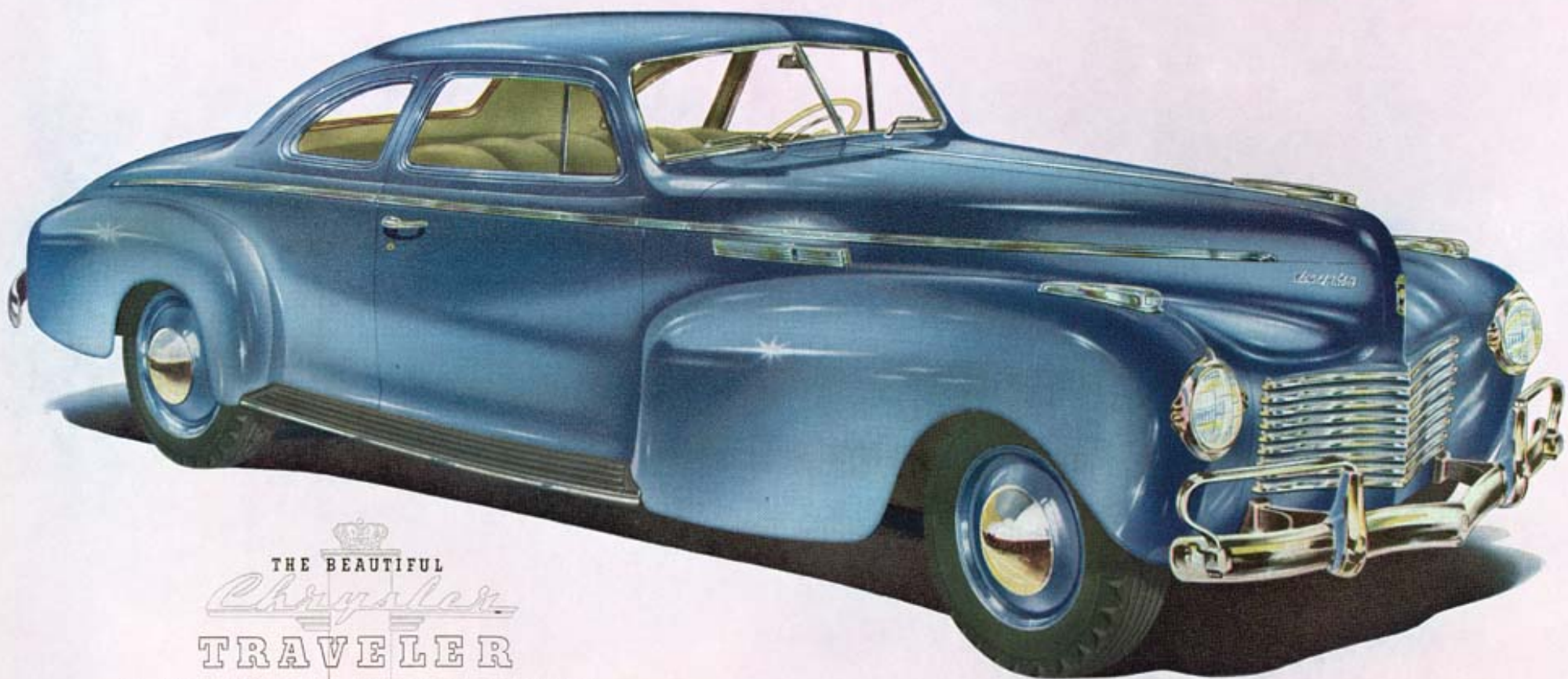
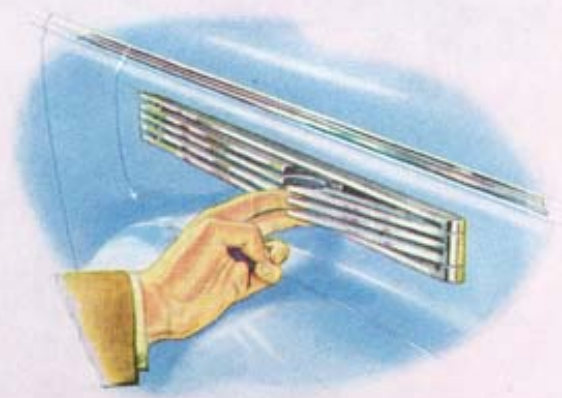

THE BEAUTIFUL
Chrysler
TRAVELER

135 HORSEPOWER

128 1/2 INCH WHEELBASE





Interior

THE BEAUTIFUL TRAVELER SIX PASSENGER COUPE



The Coupe is essentially a personal car, but this model is designed to serve a dual purpose . . . with a passenger capacity of six. Extra passengers are provided for by means of auxiliary

seats that may be folded out of sight when not in use. In effect, the rumble seat has been brought inside the body to provide the utmost in comfort and protection for occasional guest riders.

THE EIGHT PASSENGER SEDAN



THE BEAUTIFUL
Chrysler
WINDSOR
108 HORSEPOWER 139 1/2 INCH WHEELBASE

THE THREE PASSENGER COUPE *and* SIX PASSENGER COUPE



THE BEAUTIFUL
Chrysler
WINDSOR

108 HORSEPOWER

122 1/2 INCH WHEELBASE

THE VICTORIA SEDAN



THE BEAUTIFUL
Chrysler
WINDSOR

108 HORSEPOWER

122½ INCH WHEELBASE

THE CONVERTIBLE COUPE



THE BEAUTIFUL
Chrysler
WINDSOR

108 HORSEPOWER

122 1/2 INCH WHEELBASE

THE SIX PASSENGER SEDAN



THE BEAUTIFUL
Chrysler
WINDSOR

108 HORSEPOWER 122 1/2 INCH WHEELBASE



Interior

THE BEAUTIFUL CHRYSLER WINDSOR SIX PASSENGER SEDAN



The two-tone maroon interior illustrated here shows but one of the four unusual upholstery options that are available. Contrasting shades of green, brown and blue also are offered. This

beautiful Chrysler Windsor truly merits the term "de luxe" in all its fine interior appointments. It is designed for those who want unusual refinement and luxury in personal transportation.

THE SIX PASSENGER SEDAN



THE BEAUTIFUL
Chrysler
ROYAL

108 HORSEPOWER

122½ INCH WHEELBASE

THE VICTORIA SEDAN

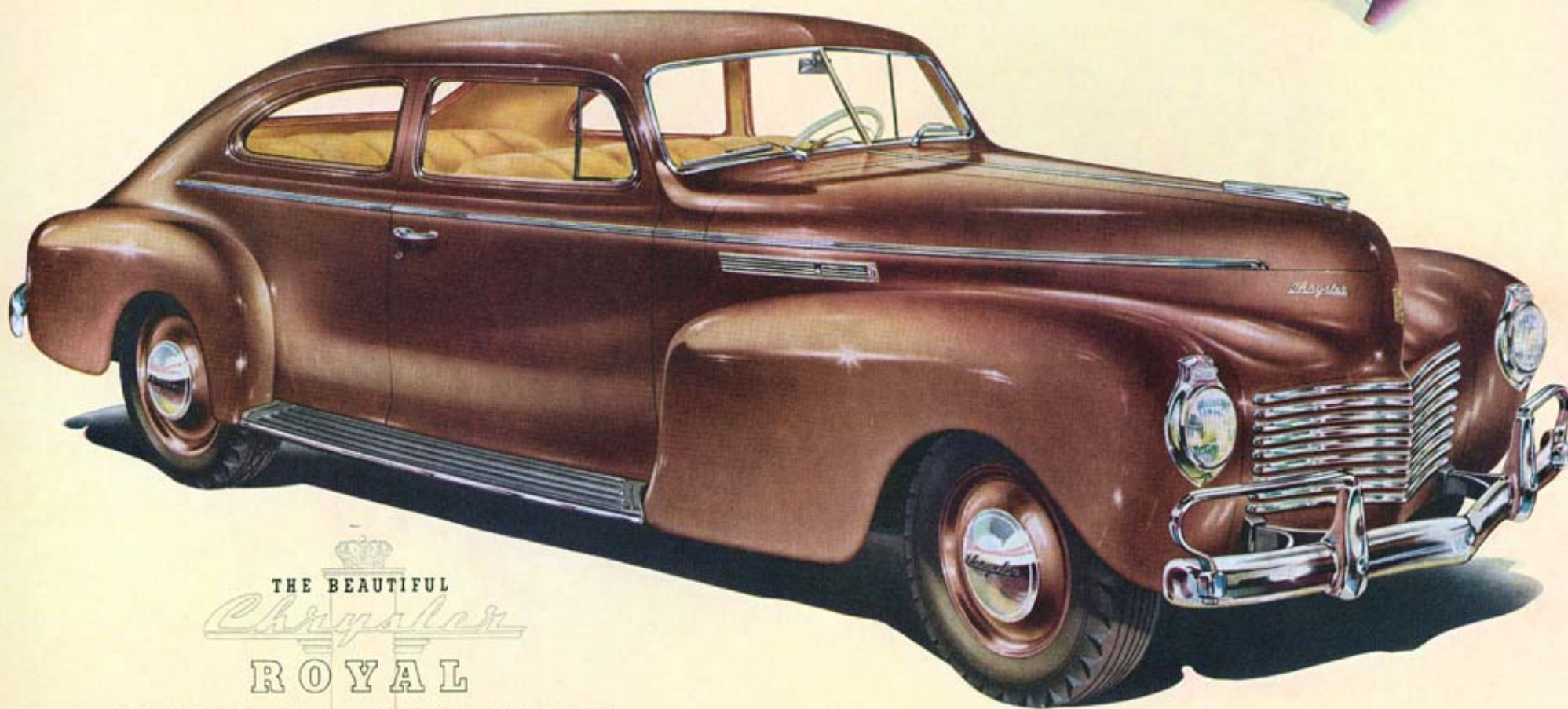
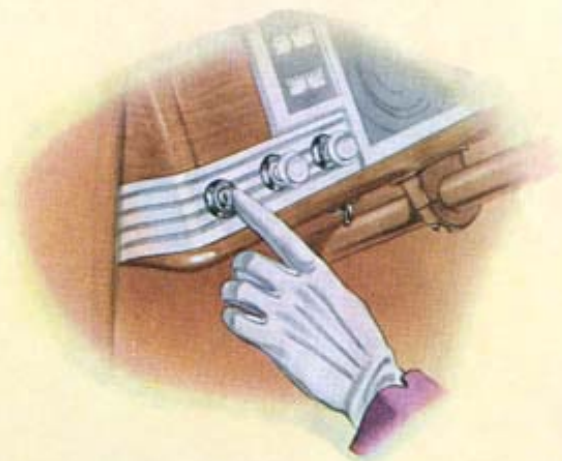

108 HORSEPOWER

122 1/2 INCH WHEELBASE

THE THREE PASSENGER COUPE *and* SIX PASSENGER COUPE

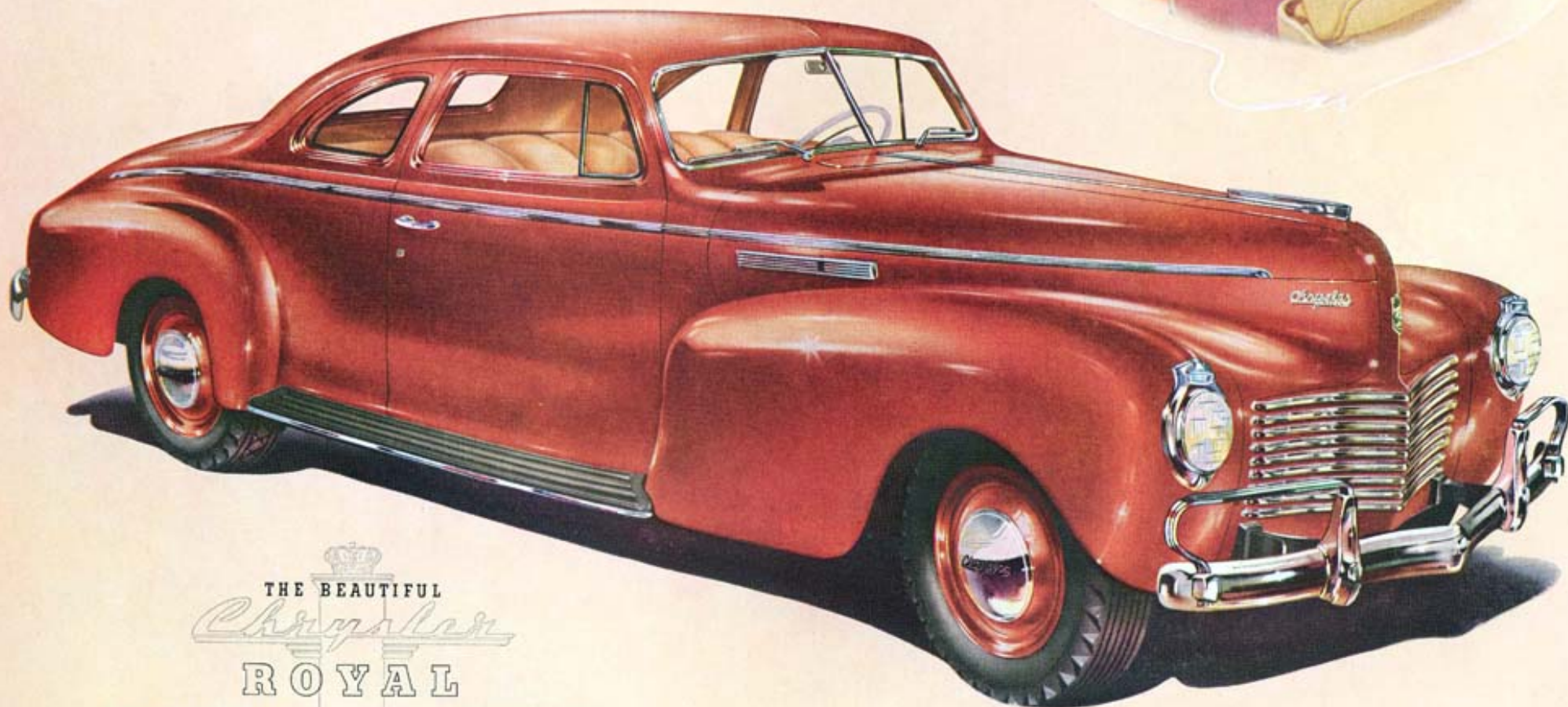

108 HORSEPOWER

122½ INCH WHEELBASE

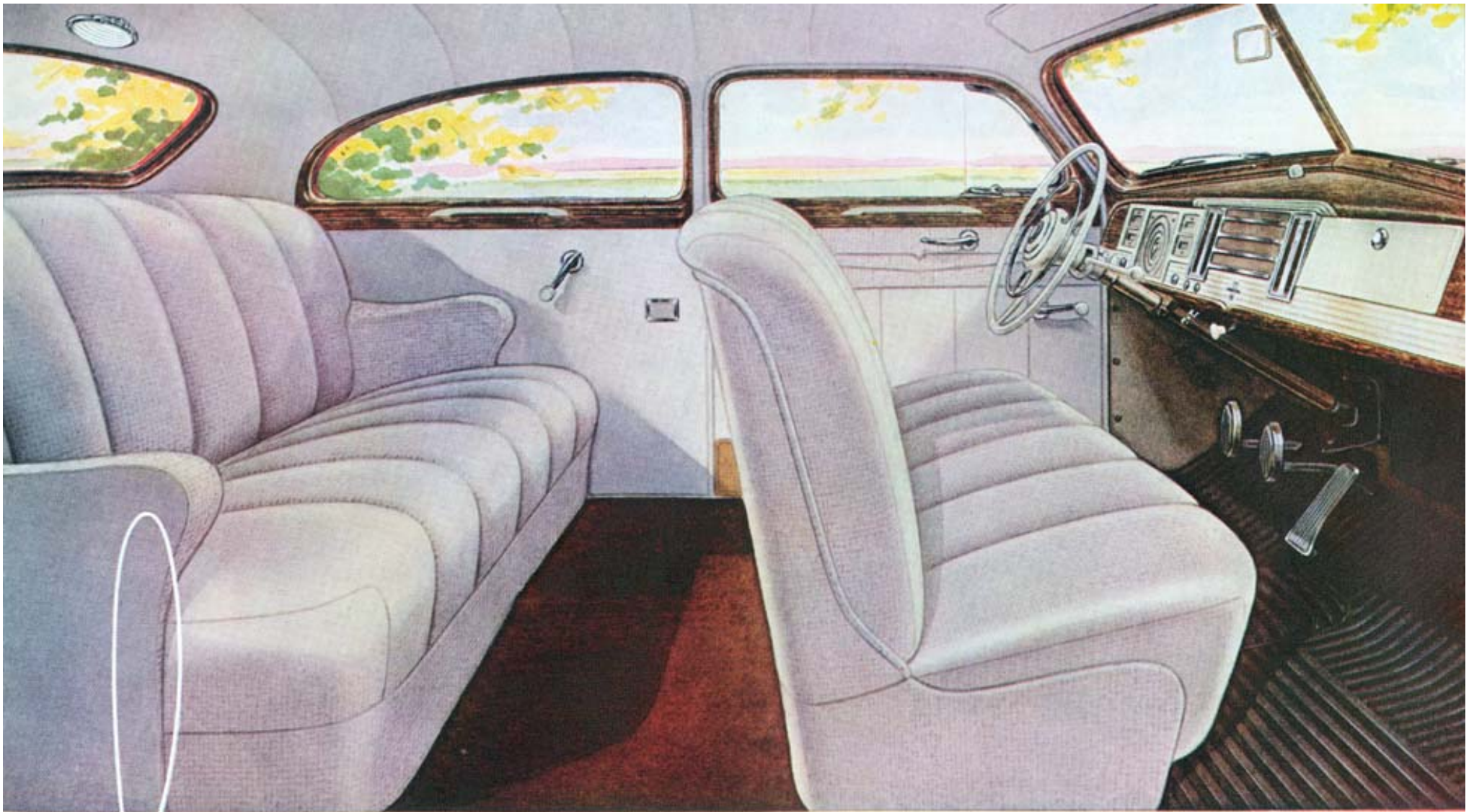

Interior

THE BEAUTIFUL CHRYSLER ROYAL VICTORIA SEDAN



The practical and ever-popular two-door grows steadily in public favor, year by year. This beautiful Chrysler interior is one that the most critical and discriminating purchaser will

be proud to choose. The smartly tailored interior you see above is upholstered in attractive pattern cloth, but a new special mohair is an optional choice for those who prefer this weave.

GREATER COMFORT THROUGH NEW WEIGHT DISTRIBUTION

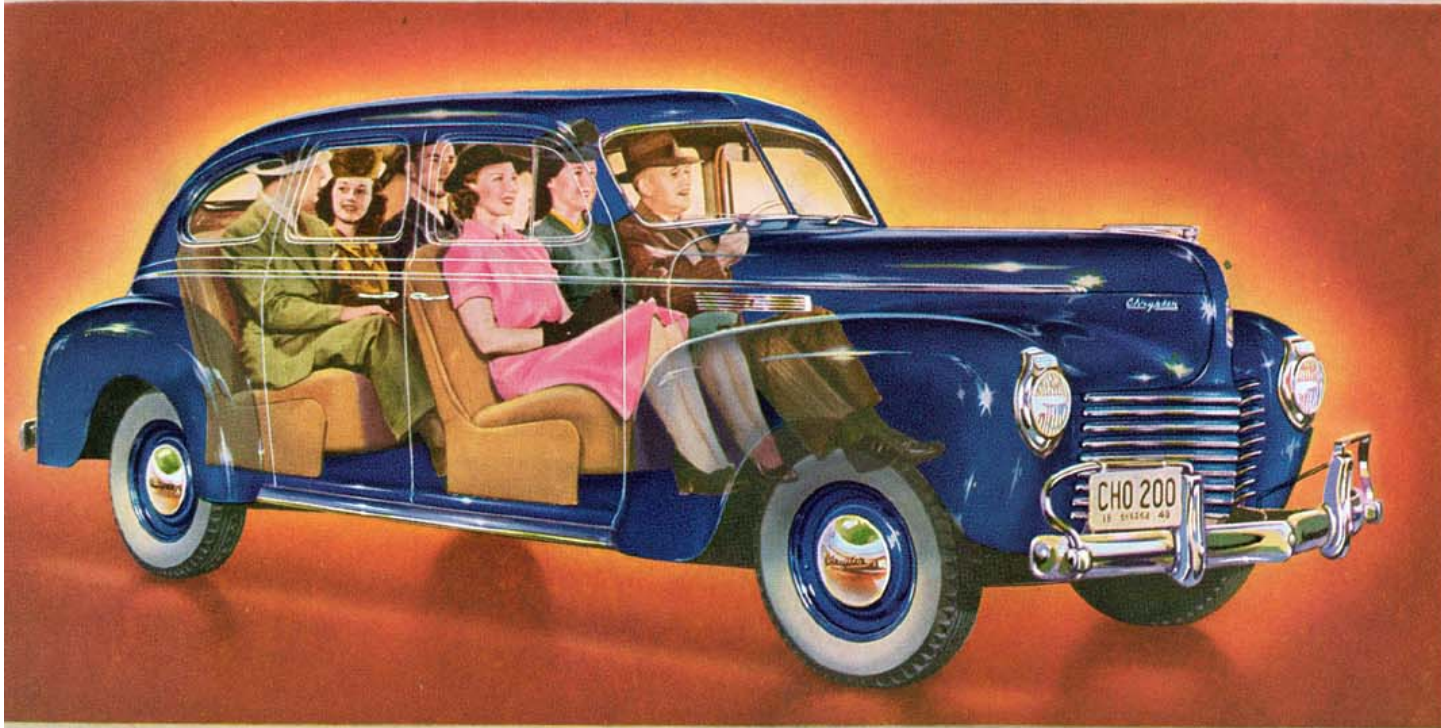

Redistribution of weight makes it possible for all passengers, including those in the rear seat, to ride in cradled comfort between the axles.

Individual coil springs, of special "Amola" steel give independent spring action to each front wheel.



Four, aero-type, hydraulic shock absorbers control both up and down movements of the springs.

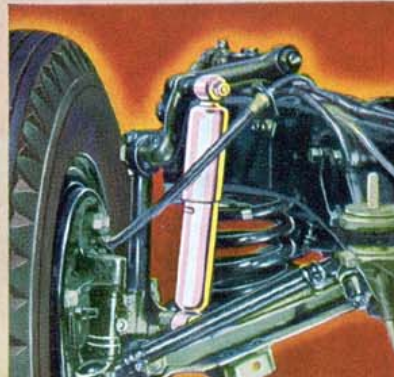

Bushings of live rubber prevent metal-to-metal contact between body and frame.

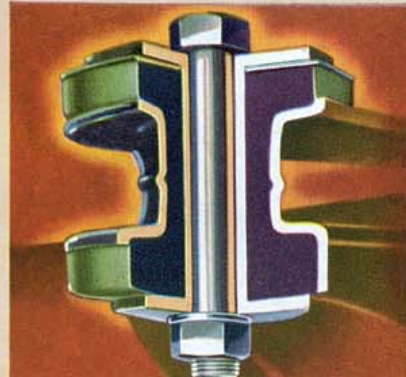

There is an abundance of practical and effective comfort features in the beautiful Chrysler for 1940. Redistribution of weight again has brought about marked improvements in riding quality. The longer wheelbase makes it possible for rear seat passengers to ride well forward of the rear axle. This principle, combined with soft, yielding Amola steel coil springs in front, and long, flexible, tapered leaf rear springs imparts riding ease that is a revelation to all who experience it. Four double-acting hydraulic shock absorbers effectively damp out heavy road shocks, and front and rear springs are calibrated to oscillate in unison at a rate closely equivalent to the human walk. The body is mounted on outriggers, fitted with live rubber bushings, which prevent metal-to-metal contact between body and frame.

The cushions which form Chrysler's chair height seats are fashioned over deep, soft coil springs, overlaid with a layer of "Air-foam" rubber that retains its shape and resiliency indefinitely. The driver's seat is adjustable for leg length over an ample range, and rises slightly as it is moved forward, to provide good vision for persons of short stature.

Other features, too numerous to mention here, have been provided in the Beautiful Chrysler for 1940, to insure the maximum of comfort and convenience for every passenger.

GREATER SAFETY THROUGH ADVANCED ENGINEERING

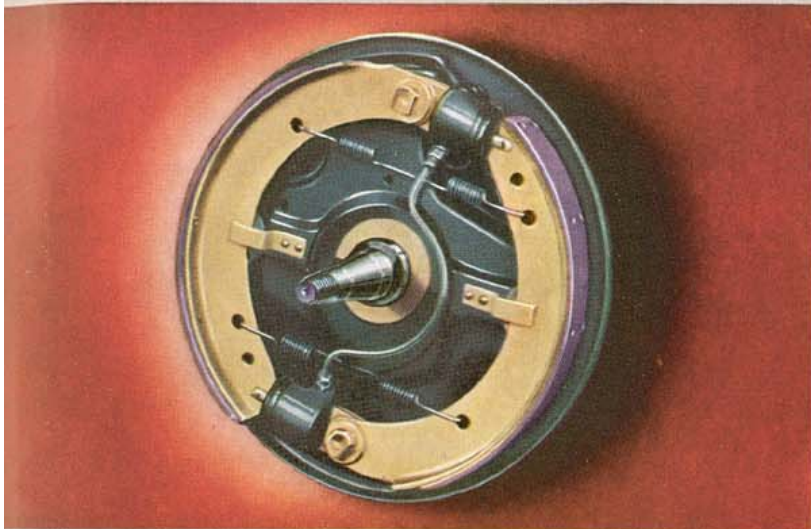

Chrysler equal-pressure hydraulic brakes are surest and safest.

The beautiful Chrysler for 1940 is likewise the safest motor car Chrysler has ever built. Long a pioneer in engineering features designed to provide greater safety for driver and passengers, Chrysler more than ever sustains that tradition in 1940 models.

An all-steel body, inseparably welded into a single unit of tremendous strength, offers the maximum of protection in every emergency.

Equal pressure hydraulic brakes, perfected by Chrysler throughout fifteen years of use, provide safe, sure, straightline stops at any speed.

Ingenious sway eliminators resist the tendency of the car to lean outward on fast turns, and individual steering tie rods make steering easier and safer.

New Sealed Beam headlamps give 50% to 65% more light when the "brights" are on, and have a glareproof passing beam, with high intensity light from both lamps deflected to the right side of the road. Sealed Beam headlamps give better light and retain their lighting efficiency over a much longer period of service.

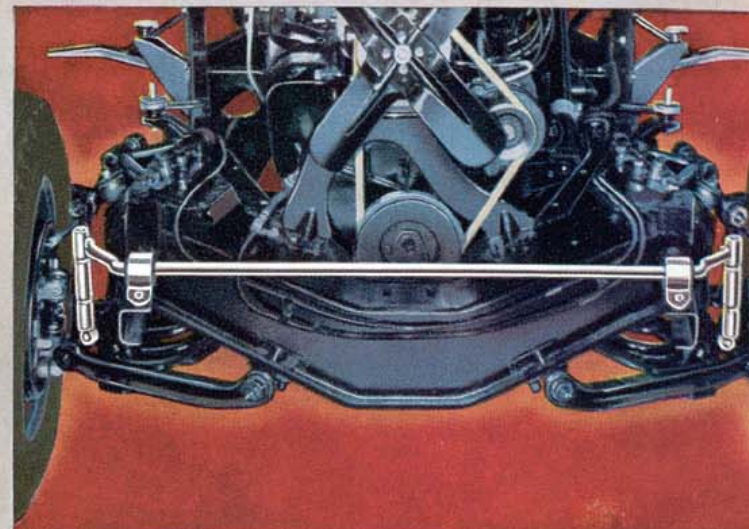

Ingenious ride stabilizers prevent the car from swaying on turns.

Chrysler bodies are a veritable fortress of steel—a welded unit, unbelievably strong and safe.



New Sealed Beam headlamps give 50% to 65% more light than the old type.



CHRYSLER'S NEW HIGH-TORQUE ENGINES

108 HORSEPOWER →

Royal and Windsor models are powered with the sensational 108 H.P. High-Torque engine—bore $3\frac{3}{8}$ ", stroke $4\frac{1}{2}$ "—piston displacement 241.5 cu. in. With premium fuel and special high compression head, increased power is obtained.

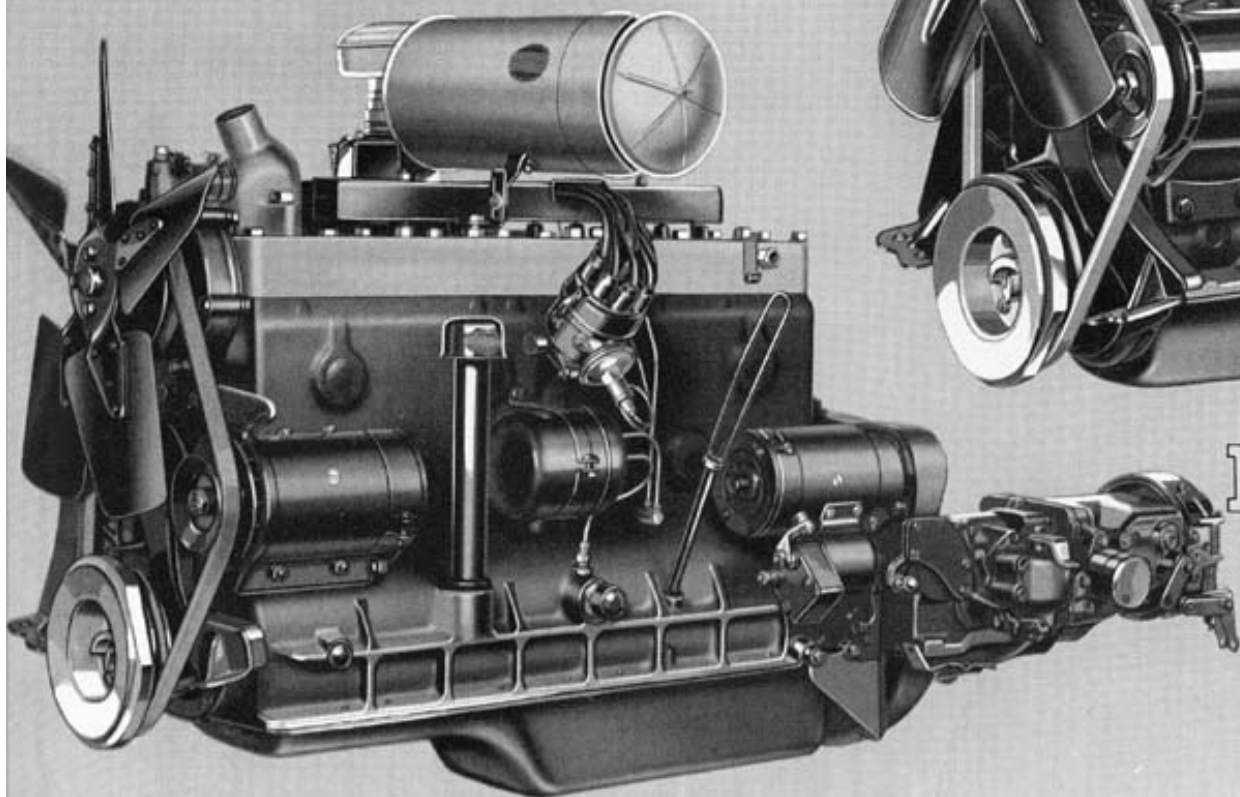
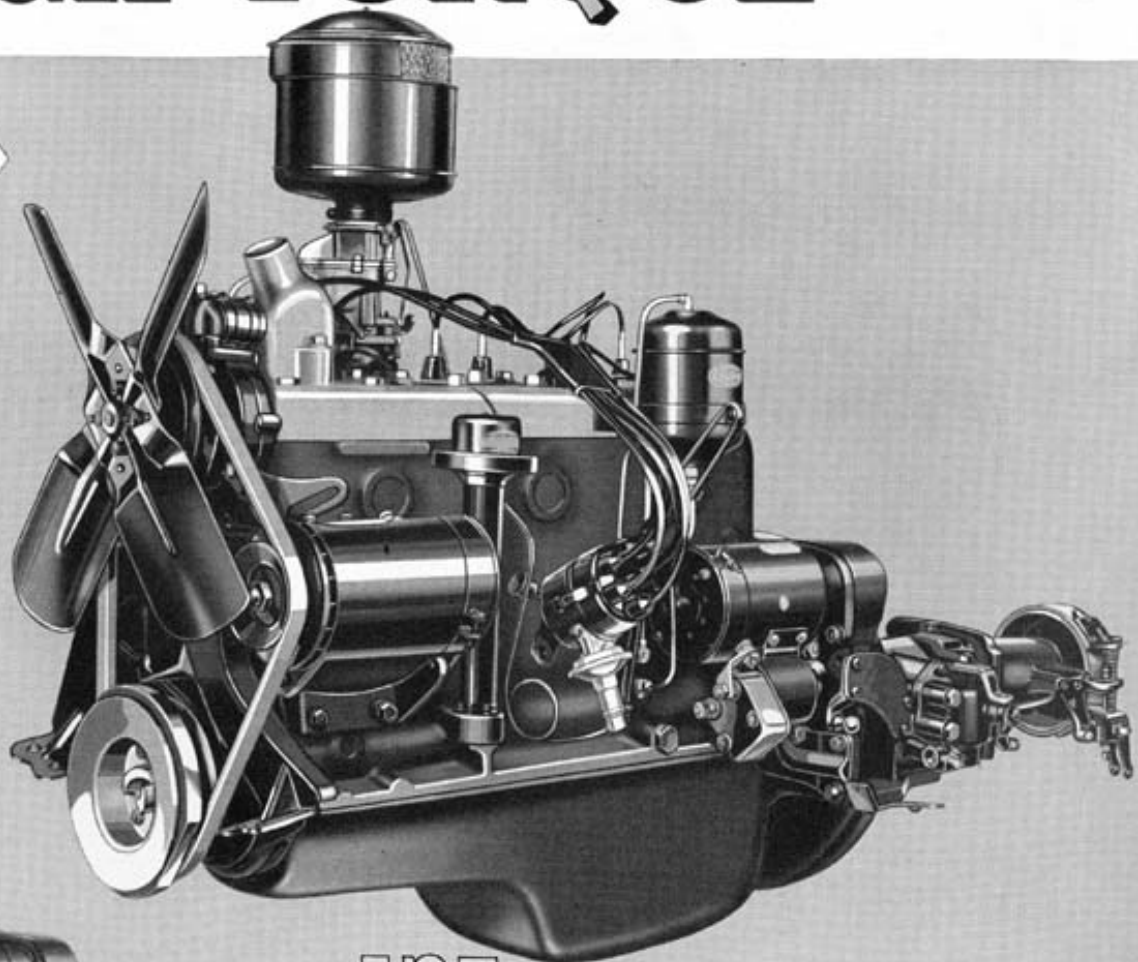

135 HORSEPOWER

For Traveler, Saratoga, and New Yorker the dynamic 135 H.P. High-Torque engine—bore $3\frac{1}{4}$ ", stroke $4\frac{7}{8}$ "—piston displacement 323.5 cu. in. With premium fuel and special high compression head, increased power is obtained.

Chrysler

CRUISE AND CLIMB TRANSMISSION

This perfected and service-proven "overdrive" transmission is available as special equipment at extra cost on the Windsor, New Yorker and Saratoga, but cannot be installed on the Royal and Traveler.

A saving of approximately 1000 engine revolutions per mile is possible with the Cruise and Climb transmission. That adds up to ten million revolutions in an average year's driving. Think what that means in terms of gasoline economy, and reduced wear on every moving part of the engine.

The Cruise and Climb transmission comes into operation at any car speed above 23 miles per hour, merely by lifting the foot momentarily from the accelerator pedal. To return to conventional gear, when increased torque is needed for fast acceleration or hill-climbing, the accelerator pedal is pressed down for an instant, against the floor boards.

A control button on the instrument panel enables the driver to lock out the Cruise and Climb transmission, whenever that may be necessitated by driving conditions.

A cut-away view of the "Cruise and Climb" transmission, which mounts behind, and becomes a part of, the standard 4-speed gear box.

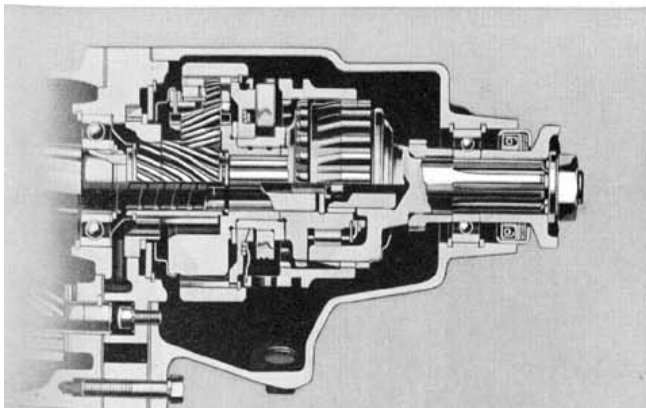

THE Chrysler FLUID DRIVE

UNIQUE IN PRINCIPLE - SENSATIONAL IN PERFORMANCE

Fluid Drive, available only in combination with the Cruise and Climb transmission, is standard equipment on the Crown Imperial, and may be had as optional equipment at extra cost on the New Yorker and Saratoga.

The chief advantage of Fluid Drive is that it enables one to drive the car, under all ordinary conditions, without using the clutch or gearshift lever. Complete control of the car is obtained through the foot accelerator and brake pedal, except when maximum acceleration is desired from a standing start—when climbing an exceptionally steep grade, or when pulling the car out of a ditch or deep chuck-hole. These conditions, in most cases, will necessitate shifting gears. However, traffic stops, slippery pavements, moderately steep hills, and tough going over muddy stretches of road may be negotiated without ever using the gearshift lever.

The cushioning characteristics of the Fluid Drive are such that the engine will not stall when the car is stopped with clutch engaged and gears in high, second, low or reverse. Moreover, it is almost impossible to cause

any jerky movement of the car, no matter how harshly the accelerator may be used. Even when the pedal is pushed suddenly against the floorboard, the car gathers momentum as smoothly as a toboggan on a gradual slope.

There is nothing new to learn about the operation of a car equipped with Fluid Drive, except to develop the habit of using the clutch and gearshift lever much less frequently.

With Fluid Drive, just as in any conventional car, the engine may be used as a brake on long, steep hills, and it may be started by towing the car, whenever necessary. Fluid Drive has no effect on gasoline consumption—the unit is self-lubricating and requires no attention beyond an occasional check to see that the fluid fills the casing to 80% capacity.

It is difficult, in the limited space available here, to do full justice to an exposition of the construction and operating principle of the Fluid Drive. For those who wish to learn more about it, there is a special booklet which may be obtained through any Chrysler dealer.

Disassembled view of Fluid Drive coupling, showing the cover, runner and driver in their relative positions. Power is transmitted solely through the fluid medium.

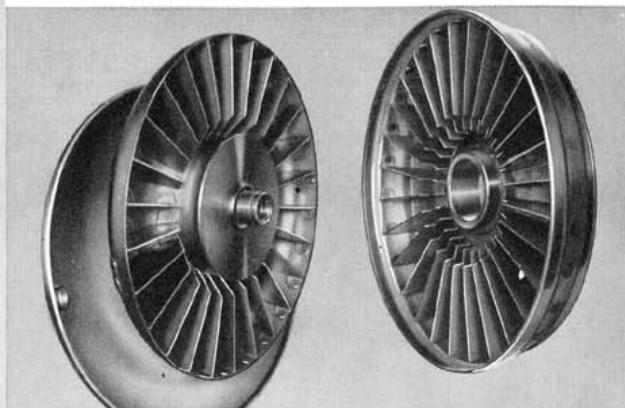

The assembled Fluid Drive coupling installed in place of the conventional flywheel. Behind it are the friction clutch and front end of transmission case.

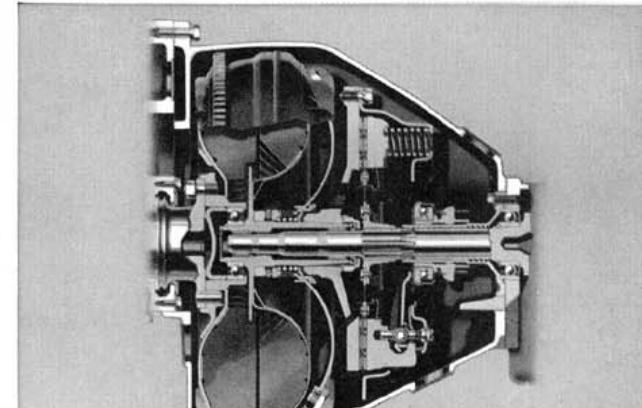

MECHANICAL



1 OVER-CENTER CLUTCH SPRING . . . an assister spring on the clutch release pedal helps to lighten the foot pressure necessary to depress the clutch . . . a feature much appreciated by women.

2 SYNCRO-SILENT TRANSMISSION . . . easy, silent shifts through all gears at all speeds. Gears are helically cut and exceptionally tough and rugged, insuring long life and quietness.

3 STANODIZED ALUMINUM ALLOY PISTONS . . . superfinished to a smooth, mirrorlike surface and coated with pure tin to prevent any possibility of scuffing or scoring during the breaking-in period.

4 FUEL PUMP . . . new inverted type . . . provides positive, uniform fuel supply under all conditions of angle or altitude.

5 FULL LENGTH WATER JACKETS . . . more effectively dissipate the heat of the cylinders, and help maintain the efficiency and economy of engine operation.

6 FLOATING POWER ENGINE MOUNTINGS . . . the engine and transmission as a unit are cradled in rubber . . . high in the front, low at the rear . . . the entire power plant is suspended in proper balance so that all power tremor is absorbed.

7 OIL FILTER . . . constantly filters and cleans the oil as it circulates through the engine . . . assuring more efficient lubrication and better oil economy.

8 TAPERED-LEAF, REAR SPRINGS . . . made of special "Amola" steel provide a greater degree of resiliency and insure the greatest possible riding comfort.

9 SWITCH MECHANISM . . . connected to foot throttle, which makes and breaks electrical connection to solenoid controlling driving lug which returns transmission to climbing range.

10 VALVE SEAT INSERTS . . . exhaust valve seats have inserts of special alloy which, because of their heat-resisting qualities, seldom if ever need attention under 30,000 miles of driving.

11 CENTRIFUSE BRAKE DRUMS . . . these drums combine the lightness and strength of steel with the heat-dissipating and wearing qualities of cast iron. Drums and linings are Superfinished to provide the maximum of surface smoothness for better heat dissipation and softer brake action.

12 LINKAGE . . . a view of the simple and positive linkage, which connects the steering wheel gearshift lever with the transmission case

FEATURES

13 **AUTOMATIC CHOKE** . . . regulates the amount of gas and air mixture to insure quick starting of the engine. Increased economy results, due to less dilution of oil.

14 **DUAL DOWN-DRAFT CARBURETOR** . . . insures an even flow of fuel to combustion chambers . . . a pump enriches the mixture momentarily when fast acceleration is needed.

15 **UNIVERSAL JOINTS** . . . friction is reduced to a minimum in these new perfected universal roller bearing joints. Because the lubricant is sealed-in, long periods of service without attention is made possible.

16 **HYPOID REAR AXLE GEARS** . . . pinion gears are set below the center of the ring gear, making possible the elimination of the tunnel in the rear compartment.

17 **AIR-COOLED GENERATOR** . . . air is drawn through the back of the generator, controlling heat, which permits increasing the power output to take care of additional electrical loads occasioned by the use of electrical accessories.

18 **FULL-PRESSURE LUBRICATION** . . . both the cylinder block and crankshaft are drilled so that oil under pressure is supplied to all vital moving parts, thereby assuring long life to bearing surfaces.

19 **CRANKSHAFT** . . . the new Chrysler crankshafts are fully balanced with integral counterweights and have extra large main bearings. All shafts are properly balanced both statically and dynamically, for smoother operation.

20 **MANIFOLD HEAT CONTROL** . . . when the engine is cold this automatic control aids in vaporizing gas mixture before it enters cylinders during the warming-up period.

21 **STARTING MOTOR** . . . by means of a solenoid switch energized by a push button on the dash, the starting pinion engages with the ring gear before current is applied to the starting motor. Starter gears do not stick or chip.

22 **CRANKSHAFT PRECISION BEARINGS** . . . new, improved, steel-backed, babbitt-lined bearings, with an exceptionally large bearing area, provide a perfect seat for the heavy counterweighted and Super-finished crankshaft.

23 **AIR-COOLED CLUTCH** . . . a fan-like pressure plate, which circulates air in large volume through the clutch, tends to control and reduce the heat.

24 **VACUUM SPARK CONTROL** . . . automatic control of spark advance or retard insures maximum engine efficiency and economy under practically all driving conditions.

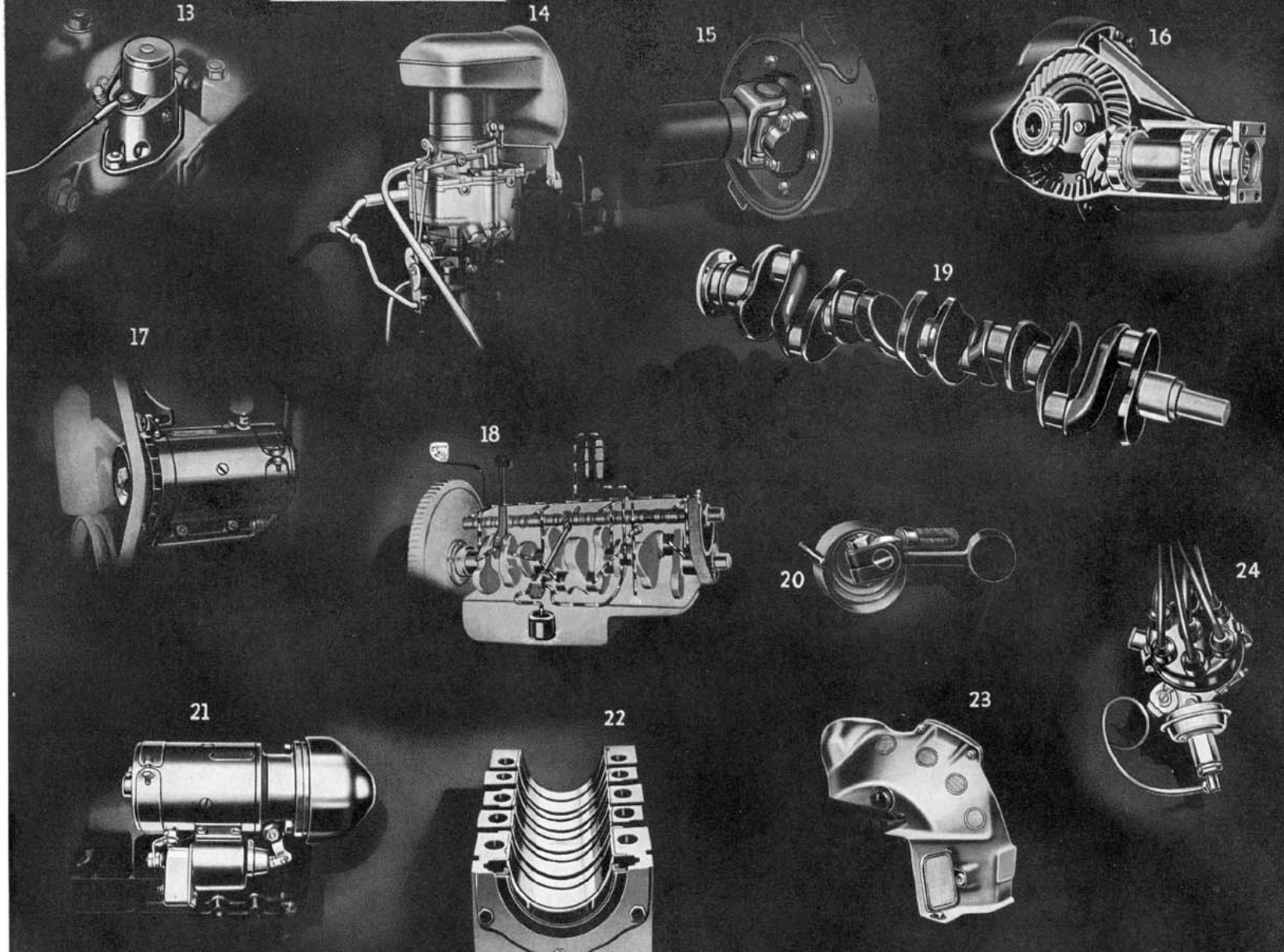

Chrysler SUPERFINISH

ASSURES GREATER INITIAL VALUE . . LONGER CAR LIFE . . QUIETER, MORE EFFICIENT PERFORMANCE

. . INCREASED OPERATING ECONOMY AND MAINTENANCE . .



If friction could be eliminated, no moving part of an automobile would ever wear out. With adequate lubrication, rotating shafts and parts having an oscillating motion would retain their original dimensions indefinitely.

To a greater degree than ever before, this ideal has been attained by Superfinish—a new method of finishing metal surfaces developed by Chrysler. Assuming adequate lubrication, this process does eliminate measureable wear, and is a tremendous step forward in achieving more precise operation and longer life for a great number of moving parts in Chrysler automobiles.

Superfinish produces an extremely smooth, mirror-like surface on flat, round, concave or convex work, either externally or internally, by means of a combination of short, multiple motions, light abrasive pressures and slow cutting speeds, with hard abrasive stones, working over a lubricant of proper viscosity.

The illustration immediately below shows only a few of the important parts of Chrysler cars which are Superfinished. The lower illustration shows flat, smooth Superfinished surfaces adhering to each other as do the finest gage blocks—by molecular attraction.

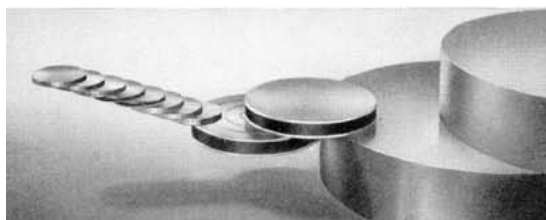
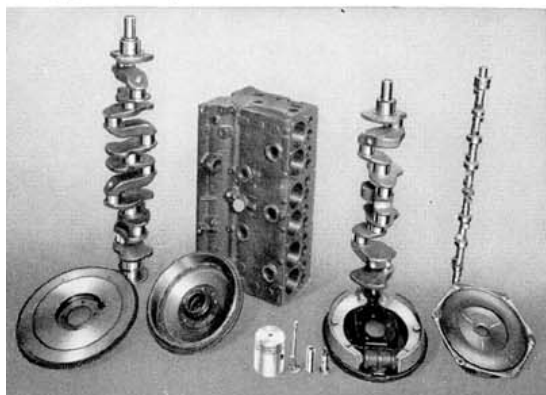

This photomicrograph shows the surface and profile of a part finished by ordinary grinding. Note the multiplicity of scratches and the jagged line of the profile. This is due to the presence of fragmented metal created on the surface by the action of the grinding wheel.

. . .

This photomicrograph shows the surface and profile of a part that has been Superfinished. Every trace of fragmented metal has been removed, exposing the true, crystalline construction of the steel, which presents a hard, dense, mirror-like surface that, when properly lubricated, is virtually impervious to wear.

Practically every part of a Chrysler chassis that is subject to wear is Superfinished. Among the most important are roller bearing races, crankshaft main bearings, crank pin bearings, camshaft bearings, cam contours, cylinder bores, pistons, piston pins, valve tappet stems and heads, intake and exhaust valve stems, flywheel clutch faces, clutch pressure plates, brake drums and brake linings.

Superfinish makes for greater gas and oil economy, due to reduction of friction and maintenance of compression in the engine. Greater smoothness and quietness of operation are attained because exceptionally close limits of fit are achieved in production, and are maintained indefinitely because normal wear is reduced almost to the vanishing point.

Superfinish assures greater value, longer life, quieter, more efficient performance and a substantial increase in economy of operation and maintenance.

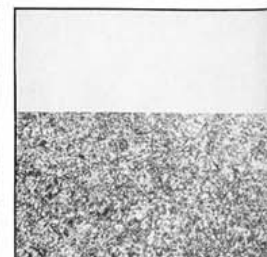
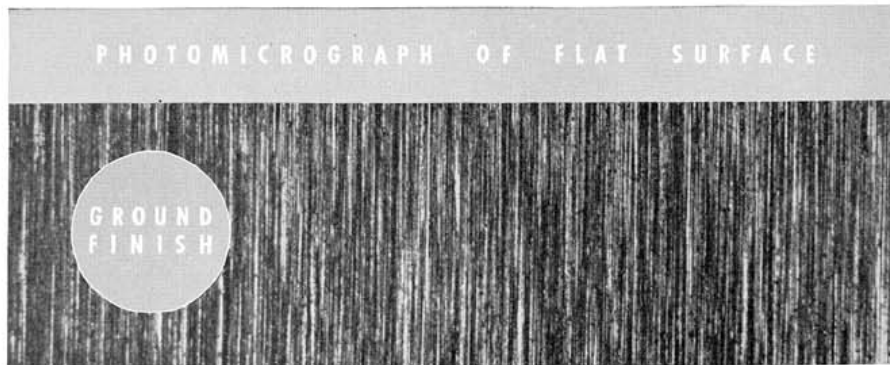

NATION - WIDE SERVICE

The Chrysler Owner's Service Policy is a broad and liberal interpretation of our responsibilities and obligations to those who buy Chrysler cars.

The certificate which is handed to every Chrysler purchaser by the dealer states this policy in clear, unequivocal terms and provides coupons detailing the items of inspection and adjustment which are performed gratis at 1000 and 2000 miles by the dealer from whom the car is purchased.

In addition, every owner is furnished with an identification card which quali-

fies him to receive prompt and efficient service from all authorized Chrysler dealers everywhere.

More than 4000 Chrysler dealers throughout the United States and Canada are prepared to render expert service to Chrysler owners. Wherever you see an Approved Chrysler Service Sign, you also will find an adequate stock of genuine Chrysler parts, special inspection and tool equipment, trained Chrysler mechanics and a disposition to serve you promptly, courteously and efficiently.

Chrysler APPROVED ACCESSORIES

The wide variety of accessories offered by Chrysler dealers is designed and built specifically for Chrysler cars. Each is thoroughly tested under actual driving conditions before it is approved for use by Chrysler owners. Each carries the unqualified approval of men who know Chrysler cars best—the engineers who designed them. Such approved accessories are your best assurance of lasting satisfaction.

Consult your Chrysler dealer first when you plan to purchase a radio, heater, clock, spot light, fog light, seat covers, defroster, radiator grille cover, wheel discs or trim rings—to mention only a few of the many approved accessory items that are available. Not only will you receive merchandise of high quality, but it will be installed and regulated by mechanics who follow factory practice in their work.



CHRYSLER*Crown Imperial***SUSPENSION (Front)**—independently sprung wheels.**AXLE (Rear)**—hypoid drive gears, semi-floating type—pressed steel housing.**BODIES (Safety Steel)**—insulated against noise, heat or cold.**BRAKES (Service)**—Chrysler four wheel hydraulic internal expanding with 12" centrifuse drums. Braking contact area 189¼ sq. in. Vacuum power unit.**BRAKES (Parking)**—external contracting on cast iron drum on propeller shaft. (Hand lever under left end of instrument panel).**CLUTCH**—fully ventilated single dry plate— asbestos-faced. Torque cushioned by special springs and through Fluid Coupling.**FLUID DRIVE (or Coupling)**—Replaces flywheel—power transmitted through fluid in coupling. No mechanical connection between engine and clutch.**COOLING SYSTEM**—water circulated by centrifugal pump—By-pass thermostat control. Fin and tube type radiator core.**CRANKSHAFT**—balanced and counterweighted. Supported on five steel backed babbitt-lined main bearings. Vibration damper.**ENGINE**—L-head, eight cylinders, water cooled, four cycle; bore 3¼", stroke 4⅞". Aluminum cylinder head—A.M.A. horsepower 33.8, developed horsepower 137 at 3400 r.p.m. With special high compression head, 143 B.H.P. is developed. Piston displacement 323.5 cu. in. Suspension; patented Floating Power engine mountings. Firing order 1-6-2-5-8-3-7-4. Full pressure lubrication to all crankshaft, camshaft and connecting rod bearings. Oil capacity 6 quarts.**ELECTRICAL SYSTEM**—shunt type generator with full voltage and current regulation—solenoid positive-shift starter, battery 19 plate 6 volt—135 ampere hour capacity automatic spark advance, with vacuum control.**FRAME**—exceptionally rigid, double drop and X girder type.**FUEL SYSTEM**—dual downdraft carburetor equipped with automatic choke and integral air cleaner and intake silencer. Fuel pump. Fuel tank capacity 20 gallons. (16.65 Imperial gallons.)**PISTONS**—Aluminum alloy. U-slot, cam ground, stanodized. Two compression and two oil rings per piston.**SHOCK ABSORBERS**—Aero-type hydraulic, double acting.**SPRINGS (Front)**—"Amola" steel coil. (Rear) Semi-elliptical with tapered leaf ends—11 leaves—length 53⅞" metal covered. Silent "U" type shackles, rubber cored bushings on front end of rear springs.**STEERING GEAR**—Semi-irreversible worm and roller type 20.25 to 1.**TIRES**—Air wheel-rib front, all weather rear Lifeguard Tubes—7.50 x 15.**TRANSMISSION**—Silent, synco mesh, helical type gears throughout. Gearshift lever mounted on steering column under steering wheel. Automatic overdrive—quick automatic disengagement.**WHEELBASE**—145½". Overall length, with bumpers, 225½".**STANDARD EQUIPMENT**—Bumpers, front and rear; Cruise and Climb Transmission, Lifeguard tubes, two windshield wipers, electric clock, dual horns, two combination stop and tail lights, rear view mirror, two adjustable sun visors, dome light, cigar lighters, ash receiver in dash and rear compartment, robe cord, foot rest, assist cords, center arm rest in rear seat, side arm rests in front, sealed beam headlights, chrome wheel discs and rings, stone shields on shock absorbers, chrome running board moulding, tools, five wheels with white sidewall tires and tubes.**CHRYSLER***Saratoga***SUSPENSION (Front)**—independently sprung wheels.**AXLE (Rear)**—hypoid, semi-floating—pressed steel housing.**BODIES (Safety Steel)**—insulated against noise, heat and cold.**BRAKES (Service)**—Chrysler four-wheel hydraulic internal expanding with 12" centrifuse drums. Braking contact area 189¼ sq. in.**BRAKES (Parking)**—external contracting on cast iron drum on propeller shaft. (Hand lever under left end of instrument panel).**CLUTCH**—fully ventilated single dry plate with assister spring on pedal-driven disc with asbestos facing. Torque cushioned by special springs.**COOLING SYSTEM**—water circulated by centrifugal pump. Thermostatic water control. Fin and tube type core.**CRANKSHAFT**—balanced and counterweighted. Supported on five steel backed babbitt-lined main bearings. Vibration damper.**ENGINE**—L-head, eight cylinders, water cooled, four cycle; bore 3¼", stroke 4⅞" A.M.A. horsepower 33.80; developed horsepower at 3400 r.p.m. 135; piston displacement 323.5 cu. in. Suspension; patented Floating Power engine mountings. Firing order 1-6-2-5-8-3-7-4. Full pressure lubrication to all crankshaft, camshaft, and connecting rod bearings. Oil capacity six quarts.**ELECTRICAL SYSTEM**—shunt type generator with full voltage and current regulation. Battery 19 plate, 6 volt, 135 ampere hour capacity. Solar spark ignition. Automatic spark advance, with vacuum control.**FRAME**—exceptionally rigid, double drop and X girder truss type.**FUEL SYSTEM**—dual downdraft carburetor equipped with automatic choke and integral air cleaner and intake silencer. Fuel pump. Fuel tank capacity 20 gallons. (16.65 Imperial gallons.)**PISTONS**—aluminum alloy U-slot cam ground—stanodized. Two compression and two oil rings per piston.**SHOCK ABSORBERS**—Aero-type hydraulic double acting.**SPRINGS (Front)**—"Amola" steel coil. (Rear) Semi-elliptical with tapered leaf ends—11 leaves—length 53⅞" metal covered. Silent "U" type shackles, rubber bushings on front end of rear springs.**STEERING GEAR**—semi-irreversible worm and roller type. 20.25 to 1.**TIRES**—Air Wheel—non-skid tread. Size 7.00 x 15.**TRANSMISSION**—silent, synco mesh, helical type gears throughout. Gearshift lever mounted on steering column under steering wheel.**WHEELBASE**—128½". Over-all length with bumpers 208½".**STANDARD EQUIPMENT**—Bumpers, front and rear; two automatic windshield wipers, rear view mirror, two adjustable sun visors, dome light, foot rest, robe cord, assist cords, ash receiver in dash and rear compartment of sedan, two combination stop and tail lights, steering wheel gear shift, chrome wheel rings and discs, chrome running board moulding, sealed beam headlamps, Rear seat center arm rest, tools, five wheels with white sidewall tires, and tubes.**CHRYSLER***New Yorker***SUSPENSION (Front)**—independently sprung wheels.**AXLE (Rear)**—hypoid, semi-floating—pressed steel housing.**BODIES (Safety Steel)**—insulated against noise, heat and cold.**BRAKES (Service)**—Chrysler four-wheel hydraulic internal expanding with 12" centrifuse drums. Braking contact area 189¼ sq. in.**BRAKES (Parking)**—external contracting on cast iron drum on propeller shaft. (Hand lever under left end of instrument panel).**CLUTCH**—fully ventilated single dry plate with assister spring on pedal-driven disc with asbestos facing. Torque cushioned by special springs.**COOLING SYSTEM**—water circulated by centrifugal pump. Thermostatic water control. Fin and tube type core.**CRANKSHAFT**—balanced and counterweighted. Supported on five steel backed babbitt-lined main bearings. Vibration damper.**ENGINE**—L-head, eight cylinders, water cooled, four cycle; bore 3¼", stroke 4⅞" A.M.A. horsepower 33.80; developed horsepower at 3400 r.p.m. 135; piston displacement 323.5 cu. in. Suspension; patented Floating Power engine mountings. Firing order 1-6-2-5-8-3-7-4. Full pressure lubrication to all crankshaft, camshaft, and connecting rod bearings. Oil capacity six quarts.**ELECTRICAL SYSTEM**—shunt type generator with full voltage and current regulation. Battery 19 plate, 6 volt, 135 ampere hour capacity. Solar spark ignition. Automatic spark advance, with vacuum control.**FRAME**—exceptionally rigid, double drop and X girder truss type.**FUEL SYSTEM**—dual downdraft carburetor equipped with automatic choke and integral air cleaner and intake silencer. Fuel pump. Fuel tank capacity 20 gallons. (16.65 Imperial gallons.)**PISTONS**—aluminum alloy U-slot cam ground—stanodized. Two compression and two oil rings per piston.**SHOCK ABSORBERS**—Aero-type hydraulic double acting.**SPRINGS (Front)**—"Amola" steel coil. (Rear) Semi-elliptical with tapered leaf ends—11 leaves—length 53⅞" metal covered. Silent "U" type shackles, rubber bushings on front end of rear springs.**STEERING GEAR**—semi-irreversible worm and roller type. 20.25 to 1.**TIRES**—Air Wheel—non-skid tread. Size 7.00 x 15.**TRANSMISSION**—silent, synco mesh, helical type gears throughout. Gearshift lever mounted on steering column under steering wheel.**WHEELBASE**—128½". Over-all length with bumpers 208½".**STANDARD EQUIPMENT**—Bumpers, front and rear; two automatic windshield wipers, rear view mirror, two adjustable sun visors, dome light, foot rest, robe cord, assist cords, ash receiver in dash and rear compartment of sedan, two combination stop and tail lights, steering wheel gear shift, chrome wheel rings, chrome running board moulding, sealed beam headlamps, Rear seat center arm rest, tools, five wheels with white sidewall tires, and tubes.

CHRYSLER *Traveler*

SUSPENSION (Front)—independently sprung wheels.

AXLE (Rear)—hypoid, semi-floating—pressed steel housing.

BODIES (Safety Steel)—insulated against noise, heat and cold.

BRAKES (Service)—Chrysler four-wheel hydraulic internal expanding with 12" centrifuse drums. Braking contact area 189¼ sq. in.

BRAKES (Parking)—external contracting on cast iron drum on propeller shaft. (Hand lever under left end of instrument panel).

CLUTCH—fully ventilated single dry plate with assister spring on pedal—driven disc with asbestos facing. Torque cushioned by special springs.

COOLING SYSTEM—water circulated by centrifugal pump. Thermo-static water control. Fin and tube type core.

CRANKSHAFT—balanced and counterweighted. Supported on five steel backed babbit-lined main bearings. Vibration damper.

ENGINE—L-head, eight cylinders, water cooled, four cycle; bore 3¼", stroke 4¾" A.M.A. horsepower 33.80; developed horsepower at 3400 r.p.m. 135; piston displacement 323.5 cu. in. Suspension; patented Floating Power. Firing order 1-6-2-5-8-3-7-4. Full pressure lubrication to all crankshaft, camshaft, and connecting rod bearings. Oil capacity five quarts.

ELECTRICAL SYSTEM—shunt type generator with full voltage and current regulation. Battery 19 plate, 6 volt, 135 ampere hour capacity. Solar spark ignition. Automatic spark advance, with vacuum control.

FRAME—exceptionally rigid, double drop and X girder truss type.

FUEL SYSTEM—dual downdraft carburetor equipped with automatic choke and integral air cleaner and intake silencer. Fuel pump. Fuel tank capacity 20 gallons. (16.65 Imperial gallons.)

PISTONS—aluminum alloy U-slot cam ground—stanodized. Two compression and two oil rings per piston.

SHOCK ABSORBERS—Aero-type hydraulic double acting.

SPRINGS (Front)—"Amola" steel coil. (Rear) Semi-elliptic with tapered leaf ends—11 leaves—length 53¾" metal covered. Silent "U" type shackles, rubber bushings on front end of rear springs.

STEERING GEAR—semi-irreversible worm and roller type. 20.25 to 1.

TIRES—Air Wheel—non-skid tread. Size 6.50 x 16.

TRANSMISSION—silent synchro mesh helical type gears throughout. Gearshift lever mounted on steering column under steering wheel.

WHEELBASE—128½". Over-all length with bumpers 208½".

STANDARD EQUIPMENT—Bumpers, front and rear; two automatic windshield wipers, rear view mirror, two adjustable sun visors, dome light, foot rest, robe cord, assist cords, ash receiver in dash and rear compartment of sedan, two combination stop and tail lights, sealed beam headlamps, steering wheel gear shift, tools, five wheels with tires and tubes.

CHRYSLER *Windsor*

SUSPENSION (Front)—independently sprung wheels.

AXLE (Rear)—hypoid, semi-floating—pressed steel housing.

BODIES—Safety Steel, insulated against noise, heat and cold.

BRAKES (Service)—Chrysler four-wheel hydraulic internal expanding with 11" centrifuse drums. Total contact area per car 155½ sq. in.

BRAKES (Parking)—independent external contracting on cast iron drum on propeller shaft. Hand lever under left end of instrument panel.

CLUTCH—fully ventilated single dry plate, with assister spring on pedal—driven disc faced with compressed woven asbestos.

COOLING SYSTEM—water circulated by centrifugal pump. Thermo-static water control. Cellular radiator core.

CRANKSHAFT—balanced and counterweighted. Supported on four babbit-lined steel main bearings.

ENGINE—L-head, six cylinders, 4 cycle. Bore 3¾", stroke 4¼" A.M.A. horsepower, 27.34, developed horsepower at 3600 r.p.m. 108. Piston displacement 241.5 cu. in. Suspension, Floating Power, Firing order 1-5-3-6-2-4. Four bearing crankshaft. Four bearing silent chain driven camshaft. Exhaust valve seat insert special alloy. Full pressure lubrication to all crankshaft, camshaft and connecting rod bearings. Positive silent gerotor oil pump located right side of crankcase. Oil capacity five quarts. Pressure gauge on dash. Level indicator on left side of crankcase.

ELECTRICAL SYSTEM—shunt type generator with full voltage and current regulation. Solenoid positive shift starter 6-volt type. Battery 15-plate, 119 ampere hours capacity. Single wire system. Solar spark ignition. Automatic spark advance with vacuum control.

FRAME—exceptionally rigid double drop X girder truss type.

FUEL SYSTEM—carburetor plain tube down draft with automatic manifold heat control and integral air cleaner and intake silencer. Fuel pump. Fuel tank capacity 17 gallons. (14.1 Imperial gallons.)

PISTONS—aluminum alloy—U-slot cam ground. Two compression and two oil rings per piston.

SHOCK ABSORBERS—hydraulic—double-acting aero-type front and rear.

SPRINGS (Front)—independent "Amola" steel coil. (Rear) "Amola" steel semi-elliptic with tapered leaf ends. Length 53¾". Number of leaves 9. Silent "U" thread type shackles on rear of rear springs. Rubber bushings on front of rear springs.

STEERING GEAR—semi-irreversible worm and roller type. 18.2 to 1.

TIRES—air wheel, non-skid tread. Size 6.25 x 16.

TRANSMISSION—synchro silent transmission. Helical gears throughout. Gearshift lever mounted on steering column under steering wheel.

WHEELBASE—122½". Over-all length with bumpers 202½".

STANDARD EQUIPMENT—Bumpers, front and rear; two automatic windshield wipers, two combination stop and tail lights, two adjustable sun visors, rear view mirror, steering wheel gear shift, dome light, robe cord, foot rest, side arm rests, assist cords, ash receiver in dash and rear compartment of sedan, sealed beam headlamps, chrome wheel rings and running board moulding, tools, five wheels with tires and tubes.

Front bumper headlamp guards, shown on cars illustrated, are special extra equipment.

CHRYSLER *Royal*

SUSPENSION (Front)—independently sprung wheels.

AXLE (Rear)—hypoid, semi-floating—pressed steel housing.

BODIES—Safety Steel, insulated against noise, heat and cold.

BRAKES (Service)—Chrysler four-wheel hydraulic internal expanding with 11" centrifuse drums. Total contact area per car 155½ sq. in.

BRAKES (Parking)—independent external contracting on cast iron drum on propeller shaft. Hand lever under left end of instrument panel.

CLUTCH—fully ventilated single dry plate, with assister spring on pedal—driven disc faced with compressed woven asbestos.

COOLING SYSTEM—water circulated by centrifugal pump. Thermo-static water control. Cellular radiator core.

CRANKSHAFT—balanced and counterweighted. Supported on four babbit-lined steel main bearings.

ENGINE—L-head, six cylinders, 4 cycle. Bore 3¾", stroke 4¼" A.M.A. horsepower, 27.34, developed horsepower at 3600 r.p.m. 108. Piston displacement 241.5 cu. in. Suspension, Floating Power, Firing order 1-5-3-6-2-4. Four bearing crankshaft. Four bearing silent chain driven camshaft. Exhaust valve seat insert special alloy. Full pressure lubrication to all crankshaft, camshaft and connecting rod bearings. Positive silent gerotor oil pump located right side of crankcase. Oil capacity five quarts. Pressure gauge on dash. Level indicator on left side of crankcase.

ELECTRICAL SYSTEM—shunt type generator with full voltage and current regulation. Solenoid positive shift starter 6-volt type. Battery 15-plate, 119 ampere hours capacity. Single wire system. Solar spark ignition. Automatic spark advance with vacuum control.

FRAME—exceptionally rigid double drop X girder truss type.

FUEL SYSTEM—carburetor plain tube down draft with automatic manifold heat control and integral air cleaner and intake silencer. Fuel pump. Fuel tank capacity 17 gallons. (14.1 Imperial gallons.)

PISTONS—aluminum alloy—"Stanodized"—U-slot, cam ground. Two compression and two oil rings per piston.

SHOCK ABSORBERS—hydraulic—double-acting aero-type front and rear.

SPRINGS (Front)—independent "Amola" steel coil. (Rear) "Amola" steel semi-elliptic with tapered leaf ends. Length 53¾". Number of leaves 9. Silent "U" thread type shackles on rear of rear springs. Rubber bushings on front of rear springs.

STEERING GEAR—semi-irreversible worm and roller type. 18.2 to 1.

TIRES—air wheel, non-skid tread. Size 6.25 x 16.

TRANSMISSION—synchro silent transmission. Helical gears throughout. Gearshift lever mounted on steering column under steering wheel.

WHEELBASE—122½". Over-all length with bumpers 202½".

STANDARD EQUIPMENT—Bumpers, front and rear; two automatic windshield wipers, two combination stop and tail lights, two adjustable sun visors, rear view mirror, steering wheel gear shift lever, dome light, robe cord, foot rest, assist cords, ash receiver in dash and rear compartment of sedans, sealed beam headlamps, tools, five wheels with tires and tubes.

Be Modern BUY CHRYSLER

